



MAP9000

High Voltage AC LED Driver

MAP9000 – High Voltage AC LED Driver

General Description

The MAP9000 is LED Driver which has high input voltage ranged from 90V to 270V. It can drive several series LEDs from rectified AC voltage.

The MAP9000 can achieve min 90% efficiency, 0.95 or higher power factor and low total harmonic distortion less than 20%.

The MAP9000 has higher LED current drive capability up to 240mA and the current can be adjustable with external resistors.

The MAP9000 is available in 6X6mm QFN 12Leads with Halogen-free (fully RoHS compliant).

For more information, please contact local MagnaChip sales office in world-wide or visit MagnaChip's website.

Features

- Triac dimming (110Vac/120Vac only)
- Flicker-free
- EMI improvement
- Power variation: $\pm 15\%$
- Constant output power control
- Higher power factor : > 0.95
- Lower total harmonic distortion : $< 20\%$
- Higher current drive capability
Up to 240mA
- 6X6mm QFN 12Leads

Applications

- AC LED Driver
- Lighting equipment
- LED Driver Power Supplies

Ordering Information

Part Number	Top Marking	Ambient Temperature Range	Package	RoHS Status
MAP9000QNRH	MAP9000	-30°C to +85°C	6X6mm QFN 12Leads	Halogen Free

Simplified Application Circuit

- AC Direct

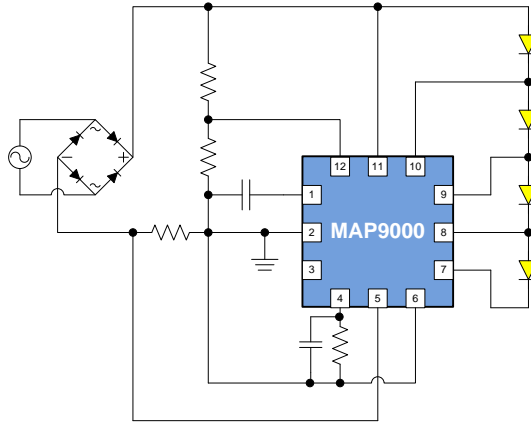

- Triac Dimming (110Vac/120Vac only)

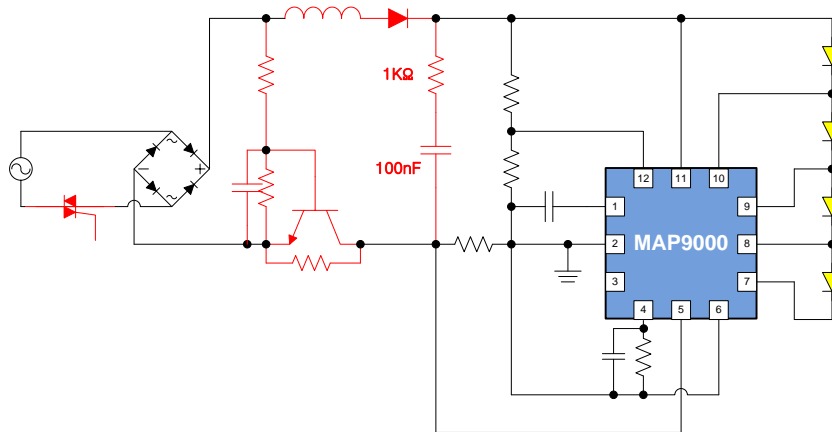

- Flicker-free

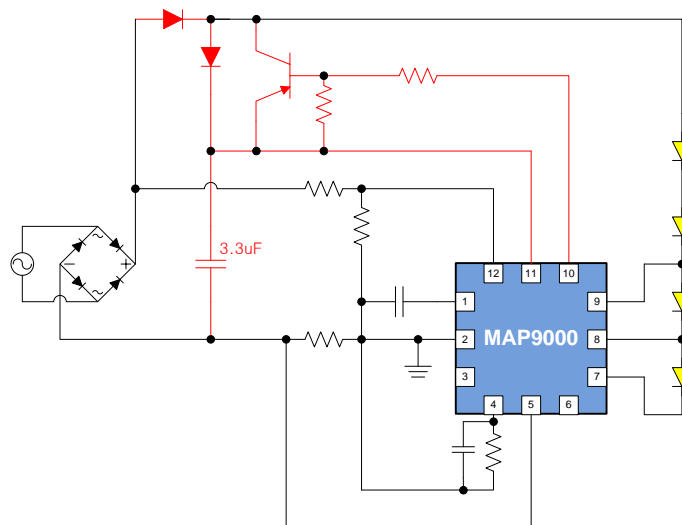

Pin Configuration & Description

- Pin Configuration

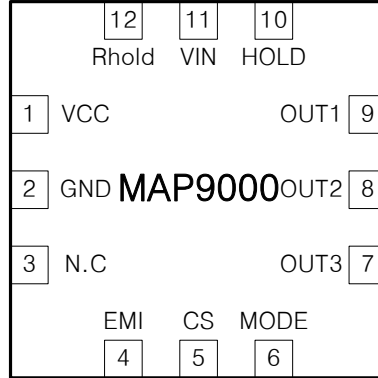

- Pin Description

Pin		Descriptions
1	VCC	VCC
2	GND	Ground
3	N.C	No Connection
4	EMI	EMI improvement
5	CS	Current sensing
6	MODE	Flicker-free mode
7	OUT3	Output – 3
8	OUT2	Output – 2
9	OUT1	Output – 1
10	HOLD	Holding-up current
11	VIN	VCC charging
12	Rhold	HOLD turn-on voltage

Functional Block Diagram

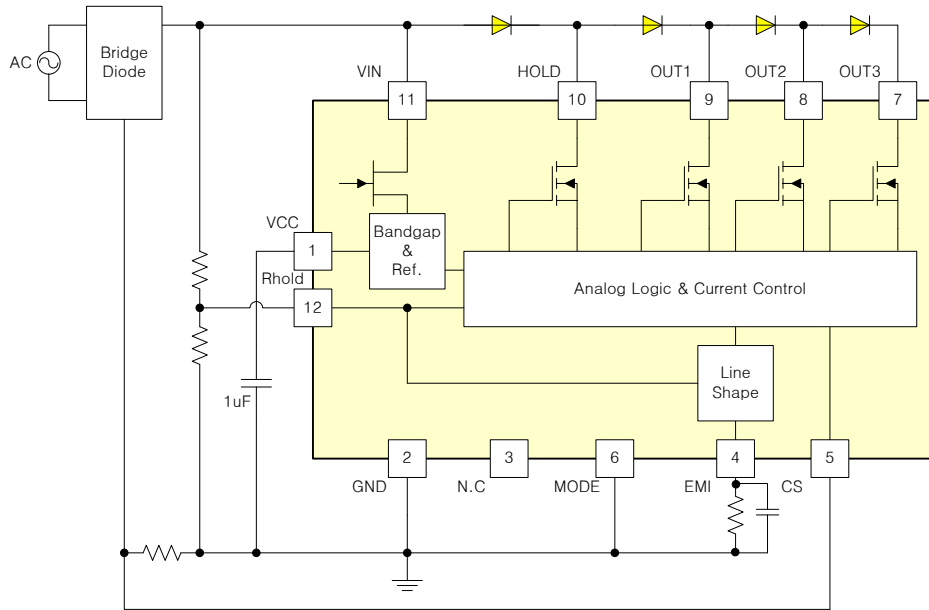

Absolute Maximum Ratings

PARAMETER		VALUE	UNIT
VIN		500	V
HOLD, OUT1, OUT2, OUT3		-0.3 ~ 500	V
EMI		-0.3 ~ 6	V
VCC, Rhold, MODE		20	V
Operating Temperature Range		-40 ~ 125	°C
Junction Temperature Range		-40 ~ 150	°C
Storage Temperature Range		-65 ~ 150	°C
Lead Temperature(soldering, 10sec)		260	°C
ESD Susceptibility	HBM All Pins (Note 1)	±2000	V
	MM All Pins (Note 2)	±200	V
	CDM All Pins (Note 3)	±1000	V

Note 1: ESD tested per JESD22A-114.

Note 2: ESD tested per JESD22A-115.

Note 3: ESD tested per JESD22C-101E

Thermal Resistance

PARAMETER		VALUE	UNIT
Thermal Resistance (θ_{JA}) , (Note4)	6X6mm QFN 12Leads	63	°C/W
Thermal Resistance (θ_{JT}) , (Note5)		8.7	°C/W

Note 4: Multi-layer PCB based on JEDEC standard (JESD51-7)

Note 5: The Metal PCB' diameter is 70mm and height is 1.6t.

Electrical Characteristics

Ta = 25°C, CS Resistance = 6.8Ω unless otherwise specified

SYMBOL	PARAMETER	TEST CONDITION	MIN	TYP	MAX	UNIT
Supply						
V _{VIN}	Input voltage range	Note 6	50		500	V
V _{VCC}	Operating voltage		-	15	-	V
I _{VCC}	Input current		300	600	900	uA
V _{UVLO}	Under voltage lockout	UVLO_H	-	12	-	V
		UVLO_L	-	10	-	V
Driver Section						
R _{hold}	R _{hold} reference voltage	V _{VIN} = 200V, V _{GND} = 0V		5.2		V
I _{D Leak}	Driver Leakage current	V _{VIN} = 200V, V _{GND} = 0V, HOLD & OUT1 ~ 3 = 400V	-	-	10	uA
I _{HOLD}	HOLD current	V _{VIN} = 200V, HOLD = 40V MODE = 0V, R _{hold} = 0V	78.3	86.3	94.2	mA
I _{OUT1}	Driver 1 current	V _{VIN} = 200V, OUT1 = 40V R _{hold} = 0V	119.3	128.0	136.7	mA
I _{OUT2}	Driver 2 current	V _{VIN} = 200V, OUT2 = 40V R _{hold} = 0V	146.0	155.2	164.3	mA
I _{OUT3}	Driver 3 current	V _{VIN} = 200V, OUT3 = 40V R _{hold} = 0V	178.7	186.2	193.6	mA
I _{OUT_SUM}	-	I _{HOLD} + I _{OUT1} + I _{OUT2} + I _{OUT3}	531.0	556.0	581.0	mA

Note 6: Stress beyond the maximum ratings listed above may incur permanent damage to the device. Operating above the recommended conditions for extended time may stress the device and affect device reliability. Also the device may not operate normally above the recommended operating conditions. These are stress ratings only.

Typical Operating Characteristics

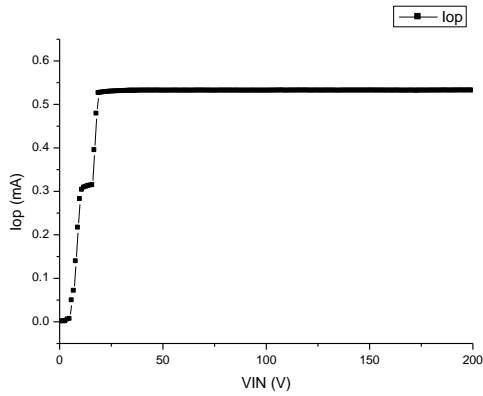

Operate Current Vs. Input Voltage

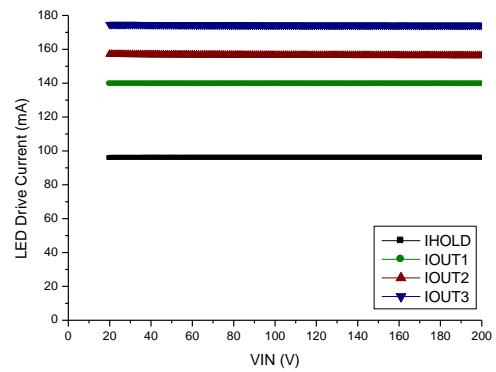

LED Drive current Vs. Input Voltage

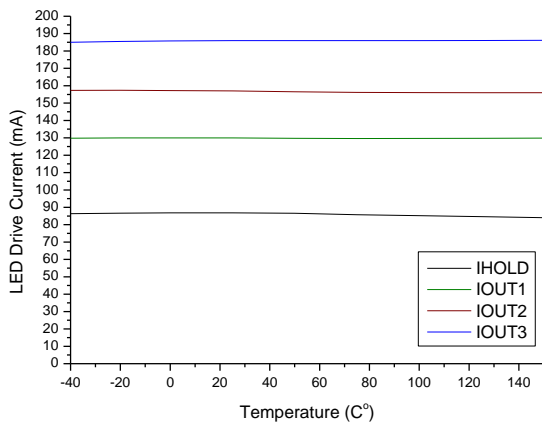

LED Drive current Vs. temperature

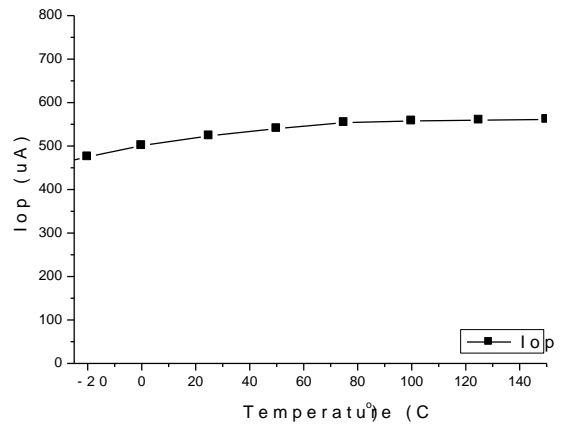

Operate Current Vs. temperature

Recommended Surge Protection Circuit

1. Circuit Diagram

The surge test using our demo-board and pass 0.5KV surge voltage at input wattage 16W

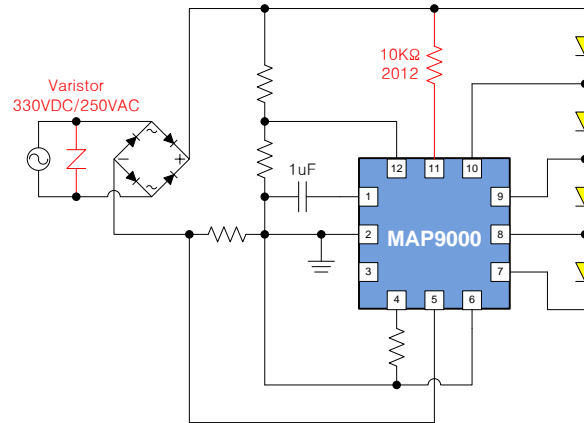

2. Demo-board layout

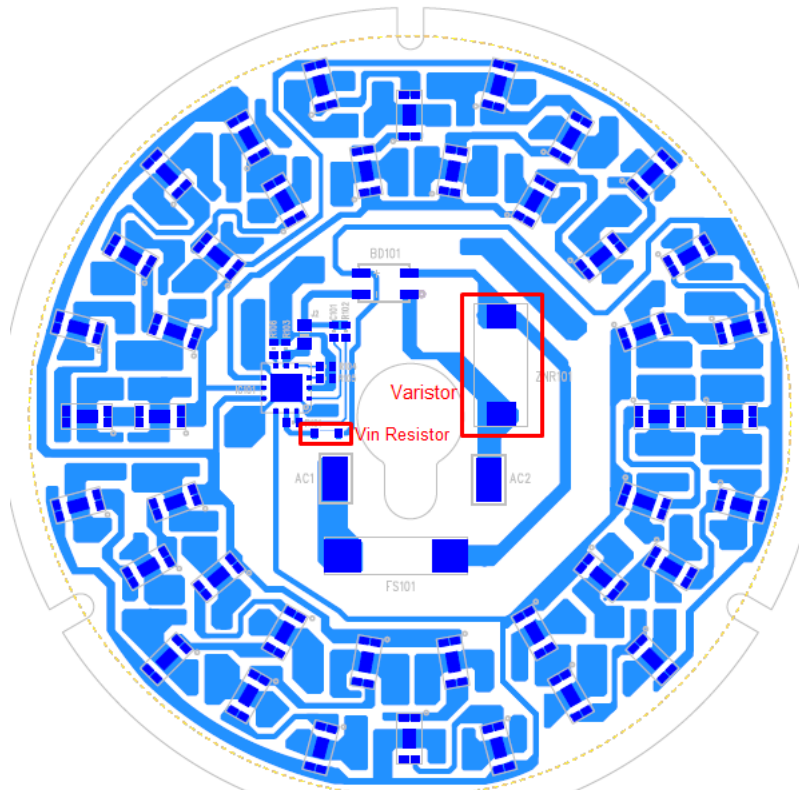

Physical Dimensions

1) QFN 6x6 12LD

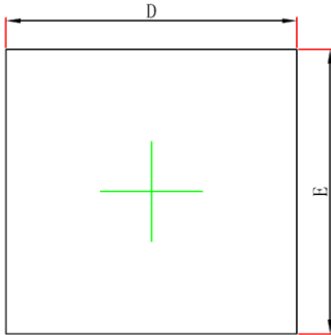

TOP VIEW

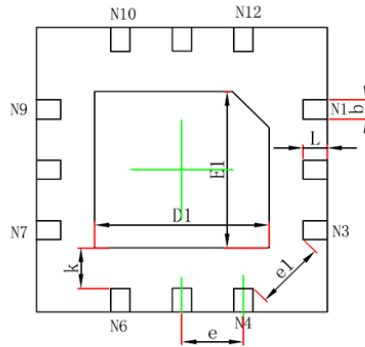

BOTTOM VIEW

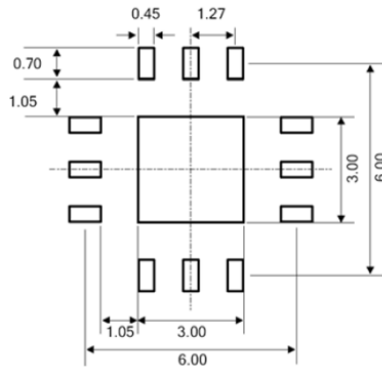

LAND PATTERN RECOMMENDATION

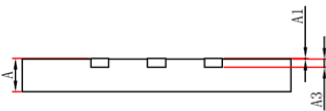

SIDE VIEW

Symbol	Dimension [mm]	
	min	max
A	0.70	0.90
A1	0.00	0.05
A3	0.203REF.	
D	5.90	6.10
E	5.90	6.10
D1	3.50	3.70
E1	3.20	3.40
k	0.20MIN.	
b	0.35	0.45
e	1.27TYP	
e1	1.45TYP	
L	0.42	0.58

MagnaChip Semiconductor Ltd. doesn't not recommend the use of its products in hostile environments, including, without limitation, aircraft, nuclear power generation, medical appliances, and devices or systems in which malfunction of any product can reasonably be expected to result in a personal injury. Seller's customers using or selling Seller's products for use in such applications do so at their own risk and agree to fully defend and indemnify Seller.

MagnaChip reserves the right to change the specifications and circuitry without notice at any time. **MagnaChip** does not consider responsibility for use of any circuitry other than circuitry entirely included in a **MagnaChip** product.

MagnaChip[®] is a registered trademark of MagnaChip Semiconductor Ltd.

MagnaChip Semiconductor Ltd.

891, Daechi-Dong, Kangnam-Gu, Seoul, 135-738 Korea
 Tel : 82-2-6903-3451 / Fax : 82-2-6903-3668 ~9
www.magnachip.com